



ITAL Produtos Industriais Ltda.
Rua San José, 648 - Parque Industrial San José
CEP 06715-862 - Cotia - SP - BRASIL
Fone: 11 4148 2518 Fax: 11 4703 5501
E-mail: ital@italpro.com.br Site: www.italpro.com.br



Blocos de Fixação Magnética Permanente - Série ECB

Os Blocos Magnéticos Permanentes da série ECB mostram um novo conceito de prender magnéticamente peças em máquinas operatrizes (CNC ou Convencional), reduzem consideravelmente o tempo no ciclo de usinagem. A força de arrancamento na vertical parte de 1200 à 2100 kgf, sendo indicados para espessuras acima de 14 mm, possibilitam usinagem em 05 faces com sómente uma preparação, devido as Chapas de Indução Magnética existentes nas faces superiores, que podem ser usinadas e são substituíveis. Possuem precisão geométrica e dimensional que garantem repetibilidade no processo de usinagem e permitem o uso unitário ou em conjunto e são aplicáveis na execução de peças simples ou complexas.



Modelo: ECB-CA
Engate Simples



Modelo: ECB-CB
Engate Duplo

Aplicação: Usinagem de Peças Médias e Grandes
Principal Vantagem: Possibilita a Usinagem de 05 faces

ACESSÓRIOS STANDARD

Chapas de Encosto e Referência
02 peças

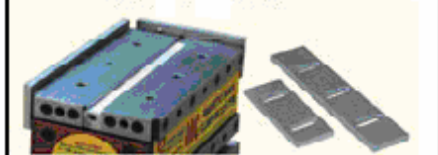

Acionamento
01 Jogo com 03 peças



02 Chapas de Indução
com parafusos de Fixação

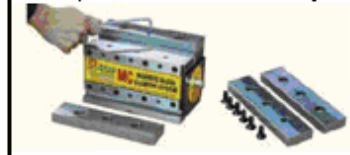

02 Guias Inferiores
com 02 Parafusos de Fixação



01 Engate Duplo de Acionamento
(Sómente para Modelos ECB-CB)





ITAL Produtos Industriais Ltda.
 Rua San José, 648 - Parque Industrial San José
 CEP 06715-862 - Cotia - SP - BRASIL
 Fone: 11 4148 2518 Fax: 11 4703 5501
 E-mail: ital@italpro.com.br Site: www.italpro.com.br



EARTH-CHAIN
BUILT FOR SPEED
www.earth-chain.com.tw

Blocos magnéticos da série ECB

Características Técnicas e Dimensionais

Modelo	Força de Arrancamento	Espessura Mínima Requerida	$G \pm 0,03$	$H \pm 0,01$	Engate de Acionamento	Peso Próprio
ECB-210CA	2100 kgf	25 mm	115	134	Simplex	36 kg
ECB-210CB					DUPLO	

LATERAL: Dimensions include 257, 234, 82, 66, 66, 16, 18, 19, and G. Features (6x) M10 holes.
FRONTAL: Dimensions include 133, 16, and 19.
TRAZEIRA: Dimensions include 115, 66, and 19. Features (4x) M10 holes.
INFERIOR: Dimensions include 124, 66, and 96. Features (4x) M12 holes.

Modelo	Força de Arrancamento	Espessura Mínima Requerida	$G \pm 0,03$	$H \pm 0,01$	Engate de Acionamento	Peso Próprio
ECB-120CA	1200 kgf	15 mm	94,5	108	Simplex	18 kg
ECB-120CB					DUPLO	

LATERAL: Dimensions include 220, 188, 64, 90, 12, 18, and G. Features (4x) M8 holes.
FRONTAL: Dimensions include 108, 16, and 13.
TRAZEIRA: Dimensions include 94, 48, and 13. Features (4x) M8 holes.
INFERIOR: Dimensions include 124, 48, and 96. Features (4x) M10 holes.



ITAL Produtos Industriais Ltda.
 Rua San José, 648 - Parque Industrial San José
 CEP 06715-862 - Cotia - SP - BRASIL
 Fone: 11 4148 2518 Fax: 11 4703 5501
 E-mail: ital@italpro.com.br Site: www.italpro.com.br



EARTH-CHAIN
BUILT FOR SPEED
www.earth-chain.com.tw

Blocos magnéticos da série ECB

Características Técnicas e Dimensionais

Modelo	Força de Arrancamento	Espessura Mínima Requerida	$G \begin{smallmatrix} +0 \\ -0,03 \end{smallmatrix}$	$H \begin{smallmatrix} +0,01 \\ -0,01 \end{smallmatrix}$	Engate de Acionamento	Peso Próprio
ECB-075CA	750 kgf	10 mm	88	78	Simplex	9,5 kg
ECB-075CB					DUPLO	

Modelo	Força de Arrancamento	Espessura Mínima Requerida	$G \begin{smallmatrix} +0 \\ -0,03 \end{smallmatrix}$	$H \begin{smallmatrix} +0,01 \\ -0,01 \end{smallmatrix}$	Engate de Acionamento	Peso Próprio
ECB-050CA	500 kgf	10 mm	61	78	Simplex	7 kg
ECB-050CB					DUPLO	



ITAL Produtos Industriais Ltda.
Rua San José, 648 - Parque Industrial San José
CEP 06715-862 - Cotia - SP - BRASIL
Fone: 11 4148 2518 Fax: 11 4703 5501
E-mail: ital@italpro.com.br Site: www.italpro.com.br



EARTH-CHAIN
BUILT FOR SPEED
www.earth-chain.com.tw

Blocos magnéticos da série ECB

Padrão de Tolerâncias Geométricas

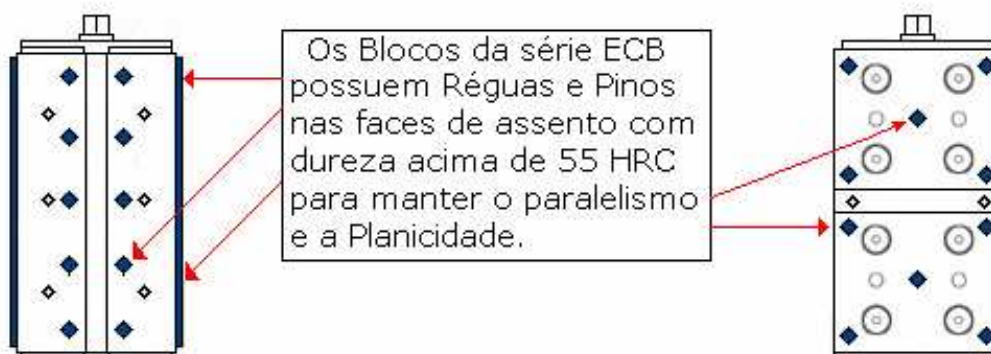
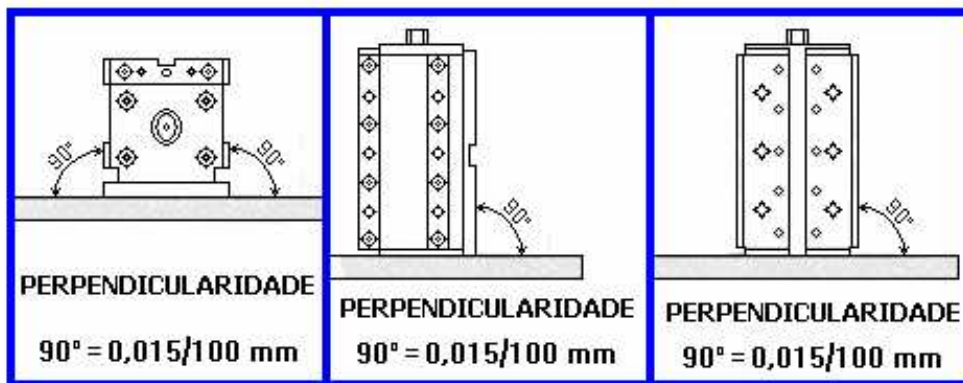

Esquema de Funcionamento

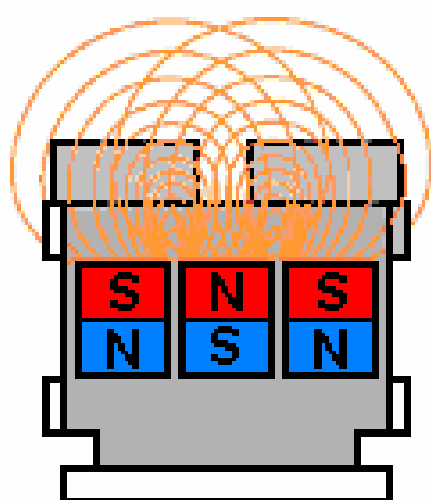

ON
(Ativado)

Imãs de Neodímio

Polo SUL

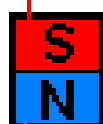

Polo Norte

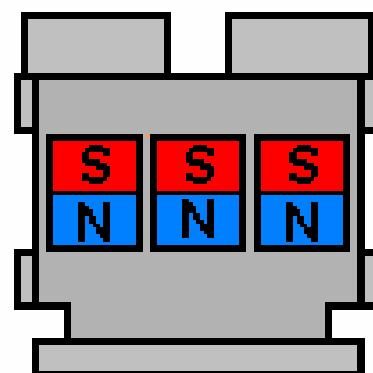

OFF
(Desativado)

BLOCOS MAGNÉTICOS DA SÉRIE ECB

Distâncias Máxima e Mínima Requerida

MODELO		ECB-210	ECB-120	ECB-075	ECB-050
Distância Lateral	Mínima	100 mm	60 mm	25 mm	25 mm
	Máxima	1000 mm	600 mm	400 mm	400 mm
Distância Frontal & Trazeira	Mínima	70 mm	40 mm	40 mm	40 mm
	Máxima	180 mm	140 mm	140 mm	140 mm
		Engate de Acionamento Standard			
		500 mm	300 mm	200 mm	200 mm
Espessura Mínima da peça		20 mm	15 mm	10 mm	10 mm

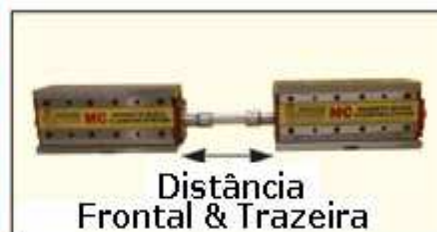

Exemplos de Aplicações



